

FEATURES

- ✔ 3 Modern Bedrooms
- ✔ Open Modern Kitchen
- ✔ Top Security System
- ✔ Premium Location
- ✔ Luxurious Finishes

 **Hanu ALSweifieh**
 **Close to Geneva Hotel**



HANU ALALSWEIFIEH PROJECT



01

ELECTRICAL

Hanu AlSweifieh Project

ELECTRICAL SYSTEMS

The following electrical systems are included in the project:

1ST SERVICE

Gas boiler



Gas boilers are the most popular choice for heating and hot water.

2nd SERVICE

Motion detector



The motion detector is an electrical device that detects nearby motion using a sensor (They are installed in the main entrance and the apartment bathroom).

3rd SERVICE

Water pump

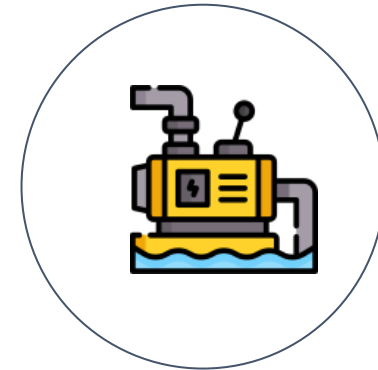

Bottom and top water pump (Wilo).

ELECTRICAL SYSTEMS

The following electrical systems are included in the project:

4th SERVICE

Main internet
distribution system



Collection of online travel portals
or travel agencies (Fiber).

5th SERVICE

Central tv system

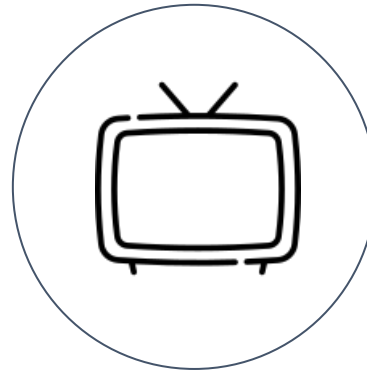

Central TV system is a mandatory
solution for multi-room units.

6th SERVICE

Earth leakage
protection system

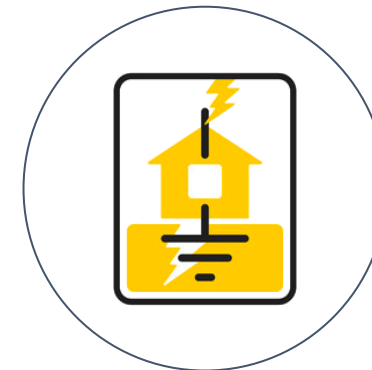

Shock-prevention device used
in electrical systems with high
Earth impedance.

ELECTRICAL SYSTEMS

The following electrical systems are included in the project:

7th SERVICE

Electric shutters
control



Easy control

8th SERVICE

Anti-theft system



Home security system

9th SERVICE

Water level meter



A water level meter is a typical equipment for measuring the exact level of water in groundwater observation wells.

ELECTRICAL SYSTEMS

The following electrical systems are included in the project:

10th SERVICE

Intercom



Smart audio and video intercom
(Commax)

11th SERVICE

Switches

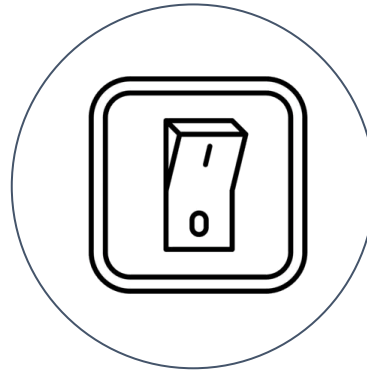

Italian Bticino sockets
& Switches

12th SERVICE

Circuit Breakers

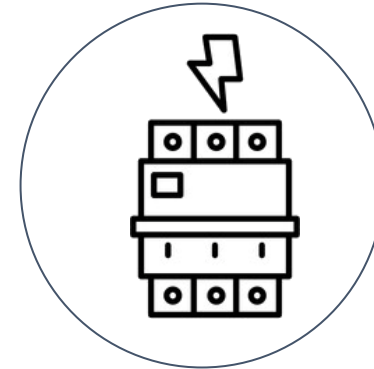

German Schneider Circuit
Breakers

Commax Color TFT LCD High-Tech Intercom Monitor CDV-70QT

7" Inch Full Touch LCD Monitor

DEVELOPMENT

TAJ AL SAFA REAL ESTATE



WIFI-enabled 7-inch smart full-touch video intercom display with smartphone connectivity. This intercom system can be used to extend your home access control to your phone. View and interact with visitors from all over the world.

COMMAX
SmartHome & Security



reddot winner 2021

DIAGRAM

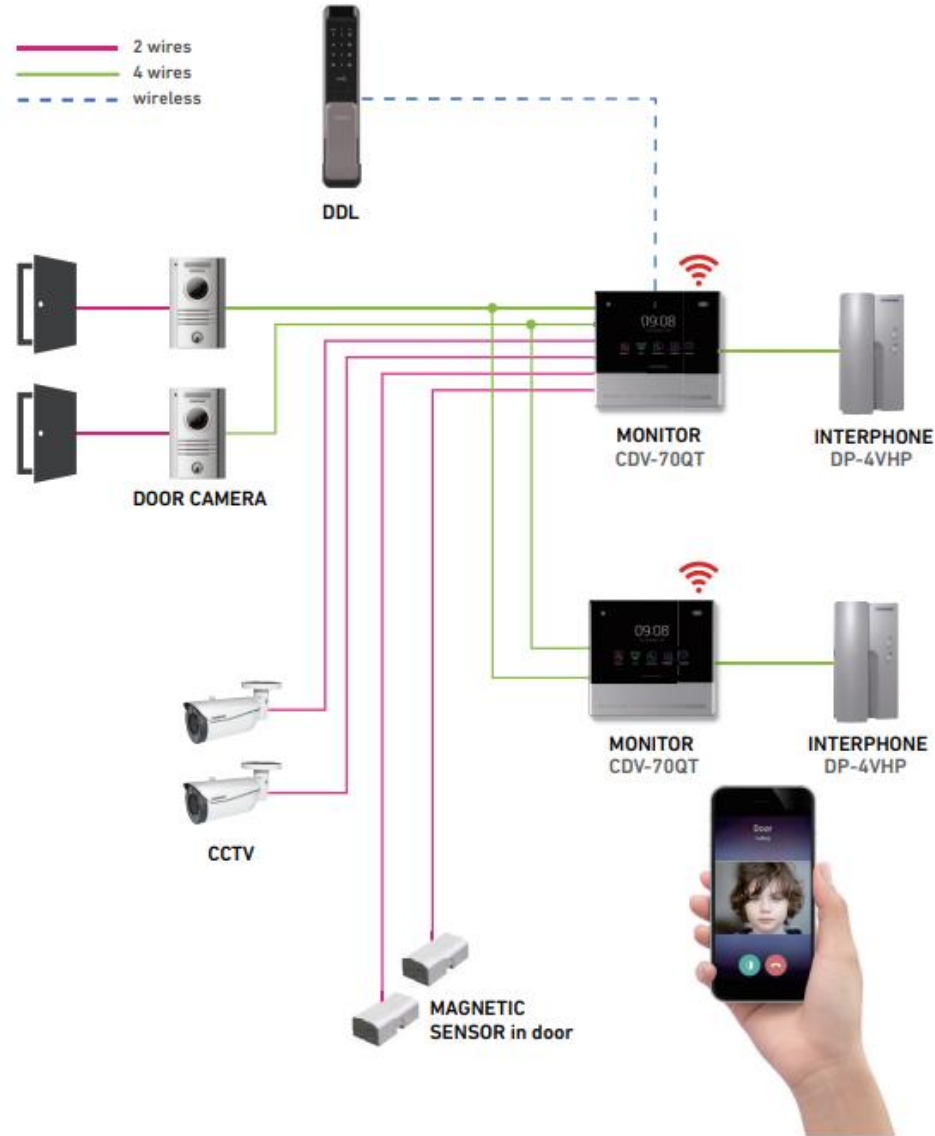

PRODUCT FEATURES

- User friendly UI/UX
- Answer video call and open door by mobile app. (Wi-Fi based)
- Connectable with 1.0MP AHD door camera
- Save the images by motion detection
- Built-in memory (50cuts, 640x360), SD card slot (128GB)
- Audio phone connectable (DP-4VHP)
- Digital door locks connectable (RF 447 MHz module option)
- 2 door cameras connectable • 2 CCTV cameras connectable
- Magnetic sensor connectable for security mode (Mobile alarm function)
- Save the visitor's image and video

PRODUCT SPECIFICATION

Power source	AC 100-240V, 50/60Hz (To SMPS)
Display	7 inch Full Touch LCD
Mount type	Wall mounted type
Memory	Built-in memory(50cuts, 640x360), SD card slot (128GB)
Resolution	1024 X 600
Network	Wi-Fi 2.4Ghz
Camera	Up to AHD 1MP
Wiring	Door camera : 4 wires Magnetic sensor(in door) : 2 wires x2
Dimension (mm)	250(W) x 210(H) x 22(D)

HIKVISION CAMERA

DS-2CE16H0T-ITPF

Specification

Camera	
Image Sensor	5 MP CMOS image sensor
Resolution	2560 (H) × 1944 (V)
Min. Illumination	Color: 0.01 Lux @ (F1.2, AGC ON), 0 Lux with IR
Shutter Time	PAL: 1/25 s to 1/50, 000 s NTSC: 1/30 s to 1/50, 000 s
Lens	2.8 mm, 3.6 mm, 6 mm fixed lens
Horizontal Field of View	85.5° (2.8 mm), 80.1° (3.6 mm), 57.1° (6 mm)
Lens Mount	M12
Day & Night	IR cut filter
Angle Adjustment	Pan: 0° to 360°; Tilt: 0° to 180°; Rotate: 0° to 360°
Synchronization	Internal synchronization
Frame Rate	PAL: 5 MP@20fps, 4 MP@25fps, 1080p@25fps NTSC: 5 MP@20fps, 4 MP@30fps, 1080p@30fps





The switches that were placed in the project are Classia models, which are made by the Italian company BTicino International, a world authority on building electric and digital infrastructures.

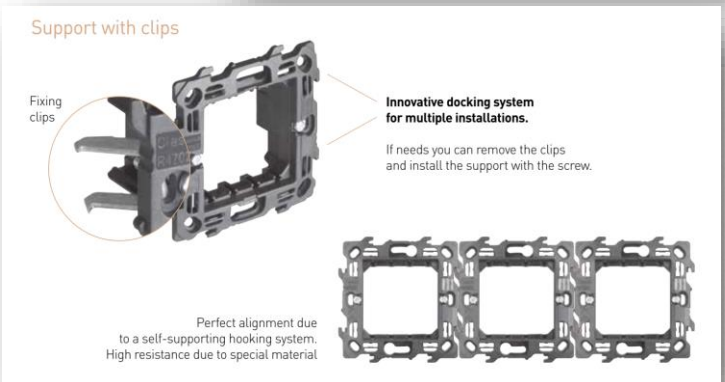
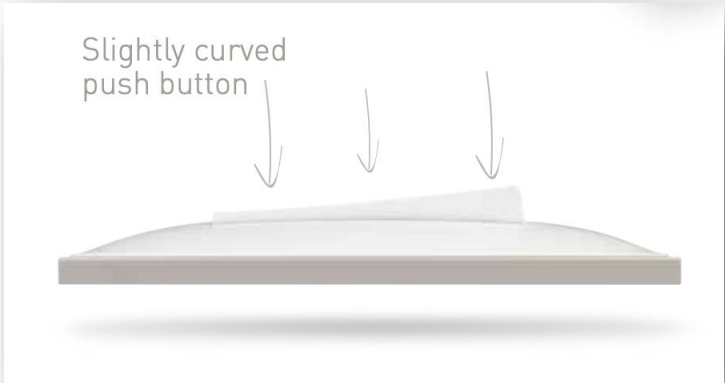

RW4001 RG4001	مفتاح مفرد أبيض مفتاح مفرد أسود	 
RW4003 RG4003	مفتاح مفرد دركسيون أبيض مفتاح مفرد دركسيون أسود	 
RW4005 RG4005 RW4005L RG4005L	كبسة جرس أبيض كبسة جرس أسود كبسة جرس مع لمبة أبيض كبسة جرس مع لمبة أسود	 
RW4001LP RG4001LP	مفتاح بولزر أبيض مفتاح بولزر أسود	 
RW4004 RG4004	مفتاح مفرد مصلب أبيض مفتاح مفرد مصلب أسود	 
RW4027 RG4027 RW4037 RG4037	مفتاح إياجور أبيض مفتاح إياجور أسود مفتاح إياجور زنتريك أبيض مفتاح إياجور زنتريك أسود	 
RW4003M2 RG4003M2	مفتاح مفرد عريض أبيض مفتاح مفرد عريض أسود	 
RW4033 RG4033	مفتاح مع حبل أبيض مفتاح مع حبل أسود	 
RW4287C7 RG4287C7	أبريز USB أبيض أبريز USB أسود	 
RW4411 RG4411	مفتاح ديمر أبيض مفتاح ديمر أسود	 
RW4139 RG4139	أبريز يونيفيرسال أبيض أبريز يونيفيرسال أسود	 
RW4141 RG4141	أبريز الماني أبيض أبريز الماني أسود	 

RW4125 RG4125	أبريز عادي أبيض أبريز عادي أسود	 
RW4180 RG4180	أبريز بور أبيض أبريز بور أسود	 
RW4202F RG4202F	أبريز ستلايت أبيض أبريز ستلايت أسود	 
RW4258RJ11 RG4258RJ11	أبريز تلفون أبيض أبريز تلفون أسود	 
RW4279C6 RG4279C6	أبريز كمبيوتر أبيض أبريز كمبيوتر أسود	 
RW4351V230 RG4351V230	جرس أبيض جرس أسود	 
RW4950 RG4950	تسكيرة أبيض تسكيرة أسود	 
R4702	جسر مربع	
R4703	جسر ثلاثي	
R4704	جسر رباعي	
R4707	جسر سباعي	

Description

German Schneider 6 kg circuit breakers installed in the project can protect each line carrying energy or supplying appliances by selecting the appropriate-sized circuit breaker, which will automatically disconnect in the event of a short circuit or a cable overload.

CIRCUIT BREAKER





BONEX LIFT

Description

Bonex Lifts Elevator Company is the world's leading elevator producer, installer, and maintenance. Bonex full package customized elevators increase building safety and value. Elevators meet strict quality standards. wormed reduction gearless combined with three-phase AC-single Motor Speed. Imported from Italy with a capacity of 3.6 kW.

- Max Load: 480 kg
- Capacity: 6 persons

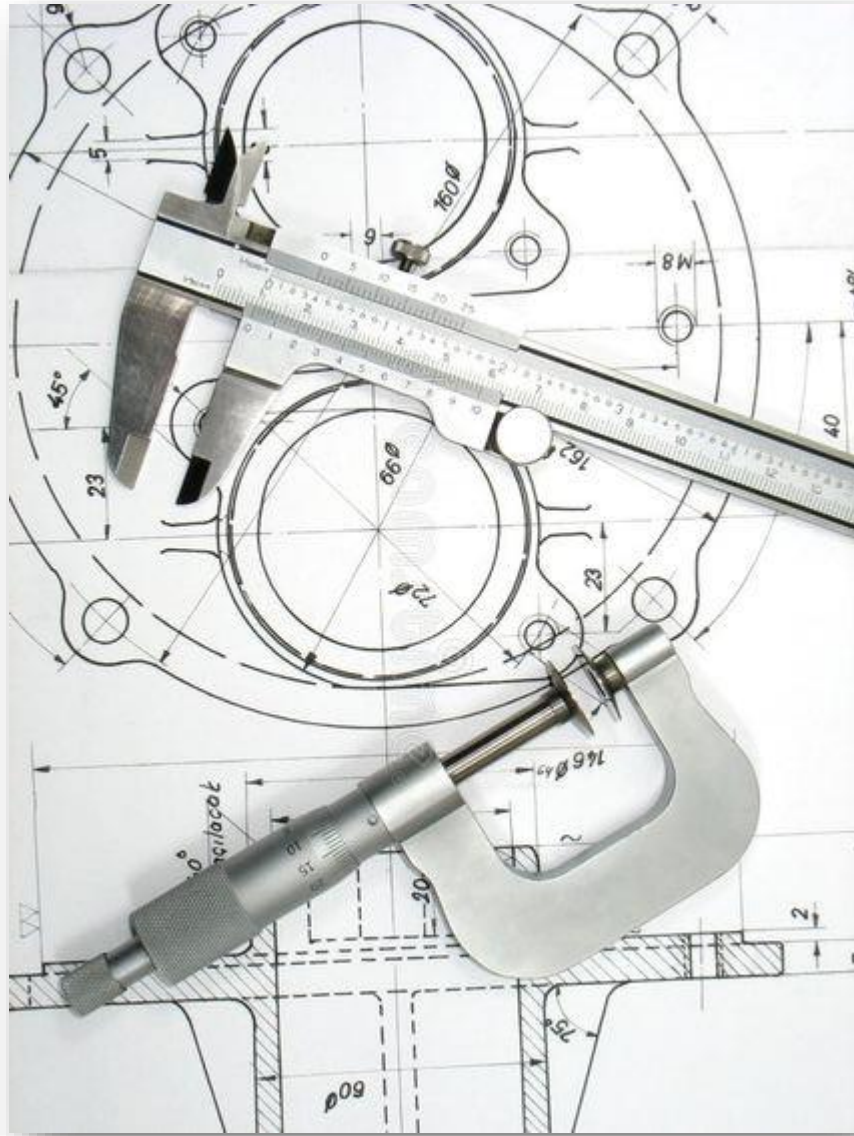

02

MECHANICAL

Hanu AlSweifieh Project

MECHANICAL SYSTEMS

The following mechanical systems are included in the project:

1st SERVICE

Drainage systems



Drainage systems are installed in accordance with local construction requirements by a certified professional.

2nd SERVICE

Ventilation

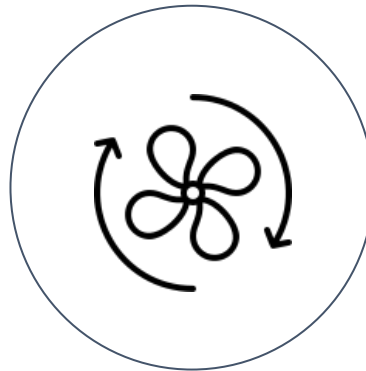

Use ducts to circulate fresh air rather than depending on airflow through small holes or cracks.

3rd SERVICE

Underfloor Heating

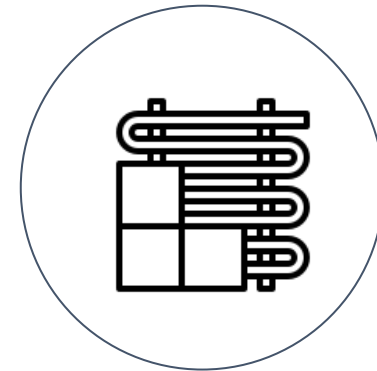

Underfloor heating is a method of heating a property by embedding strong and flexible tubing on the floor.

MECHANICAL SYSTEMS

The following mechanical systems are included in the project:

4th SERVICE

AC

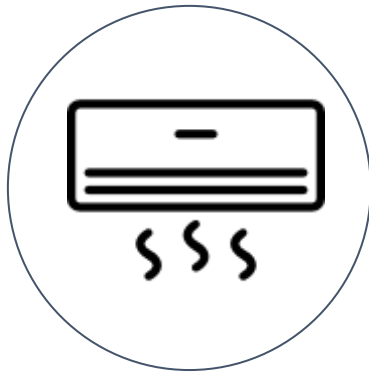

Establishing split unit points

5th SERVICE

WATER



4000 L water with Wilo pump.

6th SERVICE

Fire fighting system



Fire alarm systems ensure the safety of your home 24/7, day or night (parking).



1. DRAINAGE SYSTEM

A drainage system consists of piping that conveys sewage, rainwater, or other liquid waste to the point of disposal in the sewer system or septic tank. Its main objective is to collect and remove wastewater and keep sewer gases out of the building.

2. VENTELATION SYSTEM:

BATHROOM EXTRACT FANS SILENT-100 DESIGN 3C Series

- A collection of axial hoods with airflow rates of approximately 85 m³/h for attachment to 100 mm-diameter round ducts.
- A flexible silent block system supports the motor, absorbing vibrations and enabling deficient noise levels.
- All fans are made of injection-molded plastic, have an automated shutter, a single-phase, 230V, 50Hz, Class B motor with thermal overload protection, and all these features.
- Each fan has Class II insulation, is IP45 rated, and can withstand air temperatures up to 40°C.

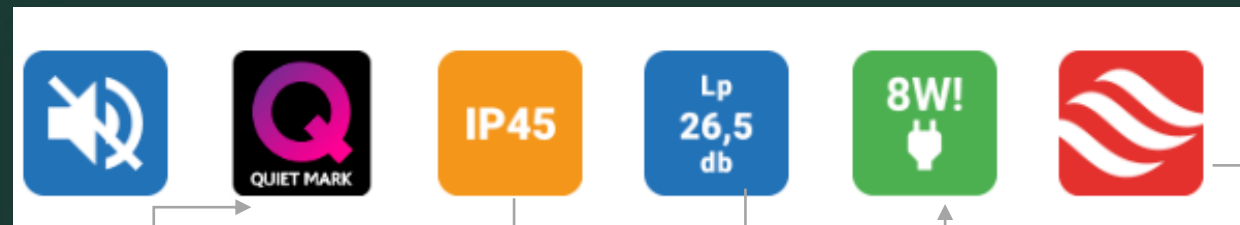

Quiet Mode

Water Protected

Low Noise

Energy Efficient

Available in
Augmented
Reality

BATHROOM EXTRACT FANS SILENT-200 DESIGN 3C Series

Axial extractors with airflow rates of 175 m³/h for connection to circular ducting with a diameter of 120 mm. All the fans are injection-molded plastic with an automatic shutter and a single-phase 230V-50Hz class B low-consumption motor with thermal overload protection. All the fans have class II insulation, are IP45 rated, and can withstand temperatures up to 40°C.

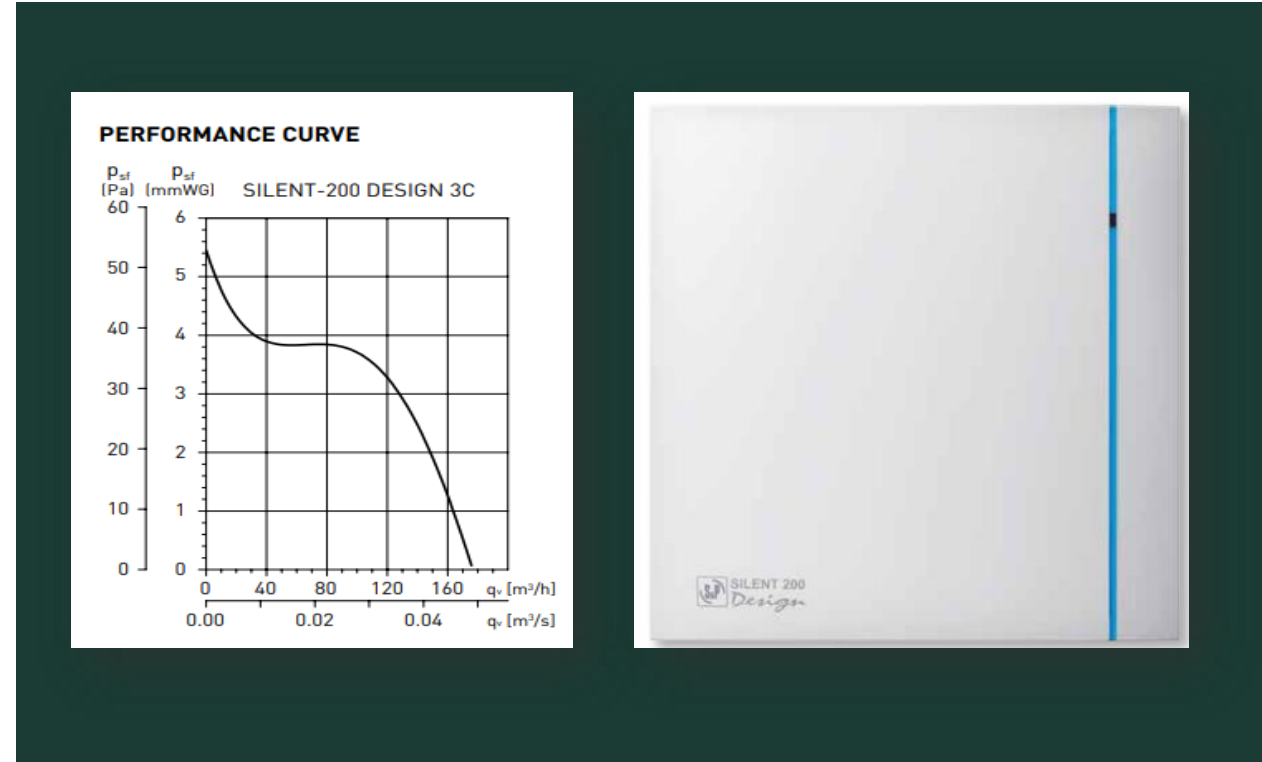

ACCESSORIES



GSA-M0 125
Flexible aluminium ducting.



GRA-75
Aluminium exterior grille.



CX-80/125
Worm drive ducting clip.



PER-100W
Back draft shutter.



WINDOW KIT 200
Accessory to allow SILENT-200 in a window.

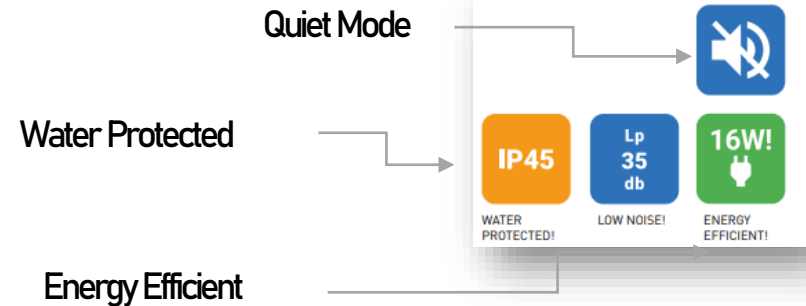

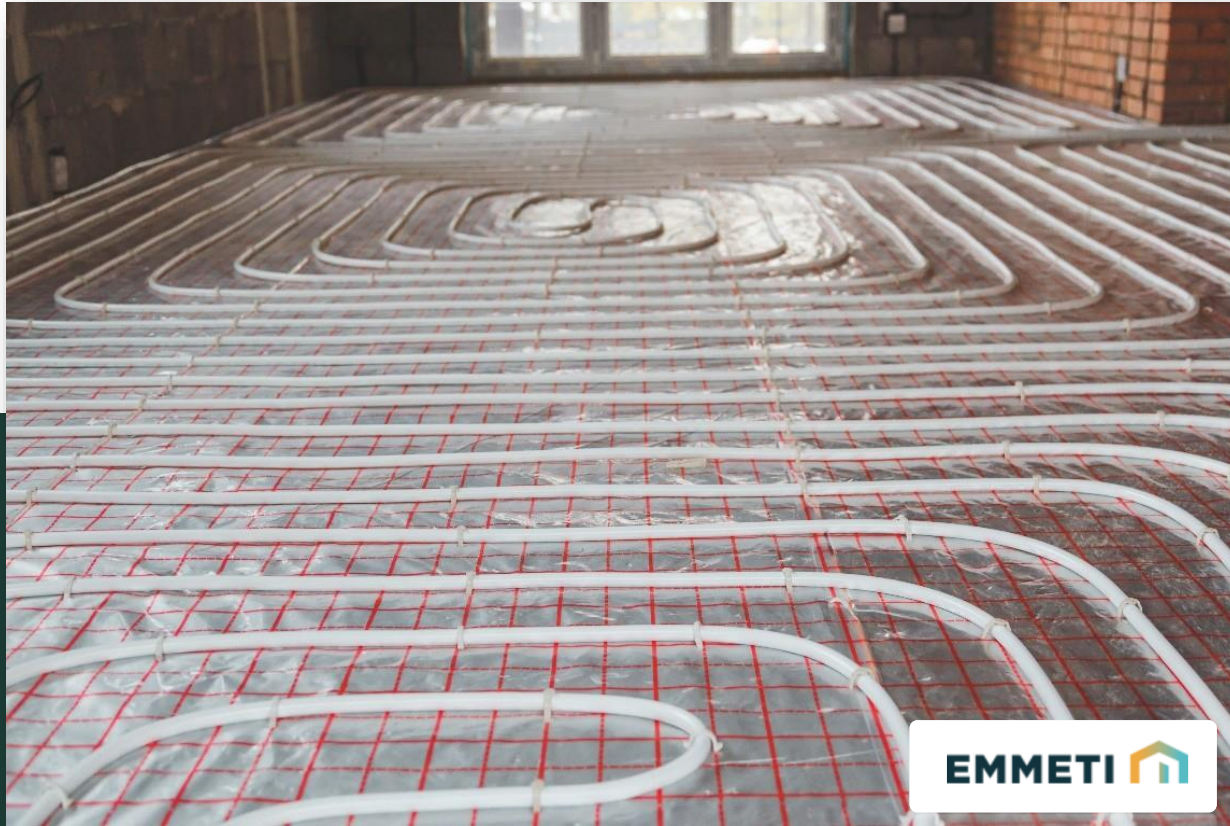

3.UNDERFLOOR HEATING

We offer a highly efficient underfloor heating system installed to the highest standards by the United Pioneering Business Company. Underfloor heating networks from the Italian emmeti system and emmeti pipes with an aluminum layer were used. Furthermore, emmeti pipes were used for the illuminator and the rest of the underfloor heating network's requirements for central lines. Heating controllers with WIFI thermostat emmeti.



EMMETI 



3. UNDERFLOOR HEATING

SINTESI MINI Wi-Fi

Wi-Fi-enabled electronic chronothermostat with weekly programming, installation on a flush-mounted box, and space for just two modules intended for controlling room temperature heating (for the winter). The free app, accessible through Google Play and the AppStore, enables complete control and programming from your smartphone or tablet. You can report any alarm situations by emailing the designated address.

WILO BOOSTER PUMP

Product advantages

- Stable water pressure due to automatic operation.
- High operational reliability and dry-running protection due to the integrated flow switch.
- Integrated thermal motor protection as standard
- Extremely low-noise operation.
- Corrosion protection through coated pump hydraulics.

Motor data

Mains connection	1~230 V, 50 Hz
Voltage tolerance	±10 %
Rated power P_2	0.2 kW
Rated current I_N	1.51 A
Rated speed n	2900 1/min
Insulation class	F
Protection class	IPX4

wilo





For more information or to book a viewing
tour get in touch with our marketing team.

00962795520443

00962799263003

<http://www.taj-alsafa.com/>

Taj_alsafa@yahoo.com



TAJ ALSAFA

REAL ESTATE DEVELOPMENT
