



TAJ ALSAFA
REAL ESTATE DEVELOPMENT

TAJ ALSAFA

REAL ESTATE DEVELOPMENT

SWIEFIEH PROJECT



INTRODUCTION

The project is distinguished by Swiefieh's unique strategic location. You can live with your family in security and comfort in your ideal and one-of-a-kind dream home thanks to the residential project's distinctive architectural style, which offers flats of various sizes with modern and environmentally suitable standards.



TAJ ALSAFA
REAL ESTATE DEVELOPMENT

A Jordanian company specialized in constructing residential buildings and providing apartments to provide residents with comfort and meet their needs.



01 EXTERIOR

SWIEFIEH PROJECT



PROJECT SPECIFICATIONS

The project utilized the Astra stone, which has high strength, a thickness of 5.2 cm, and a degree of water absorption of (0.01). The Royal Scientific Society has tested it for its ability to prevent water and moisture absorption.

EXTERIOR

TajAlSafa

TAJ AL SAFA REAL ESTATE DEVELOPMENT



AL SWIEFIEH PROJECT

PARKING

TajAlSafa

TAJ AL SAFA REAL ESTATE DEVELOPMENT



Parking details



PARKING



- Each flat has one allocated parking space.
- Motion sensor outdoor light fixture.
- Security systems.
- One Store for each apartment.
- High-Quality Grey Basalt tile has been used for the floors.

LANDSCAPE DESIGN

TajAlSafa

TAJ AL SAFA REAL ESTATE DEVELOPMENT

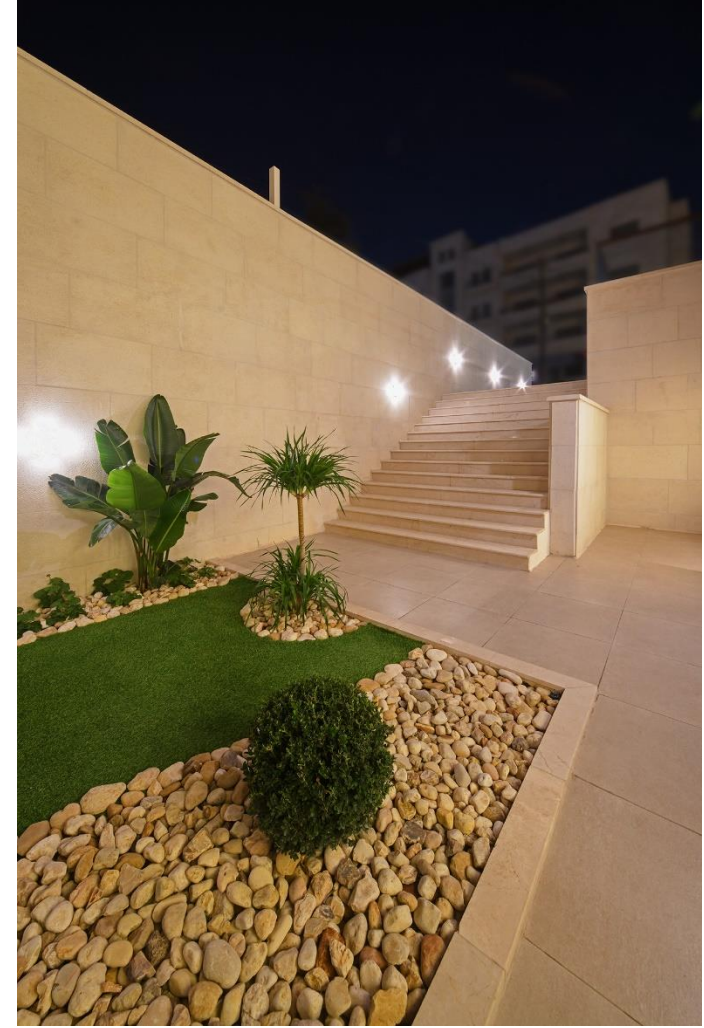

AL SWIEFIEH PROJECT

LANDSCAPE DESIGN

Taj Al Safa

TAJ AL SAFA REAL ESTATE DEVELOPMENT



AL SWIEFIEH PROJECT

LANDSCAPE DESIGN

Taj Al Safa

TAJ AL SAFA REAL ESTATE DEVELOPMENT



outdoor area



AL SWIEFIEH PROJECT

LANDSCAPE DESIGN

TajAlSafa

TAJ AL SAFA REAL ESTATE DEVELOPMENT



AL SWIEFIEH PROJECT



ENTRANCE

ENTRANCE

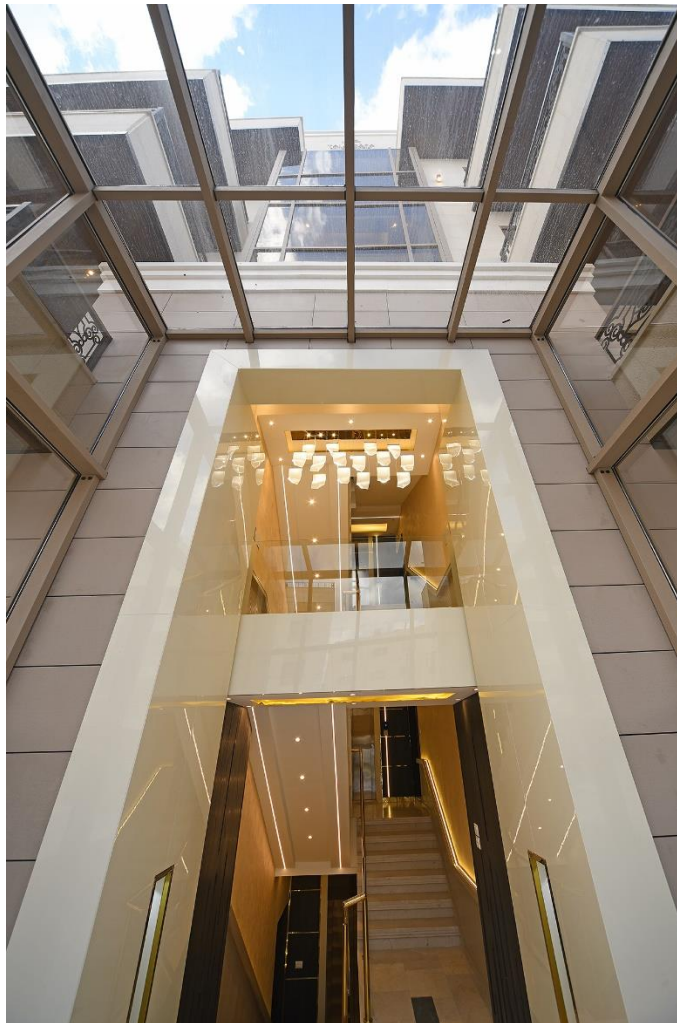

ENTRANCE

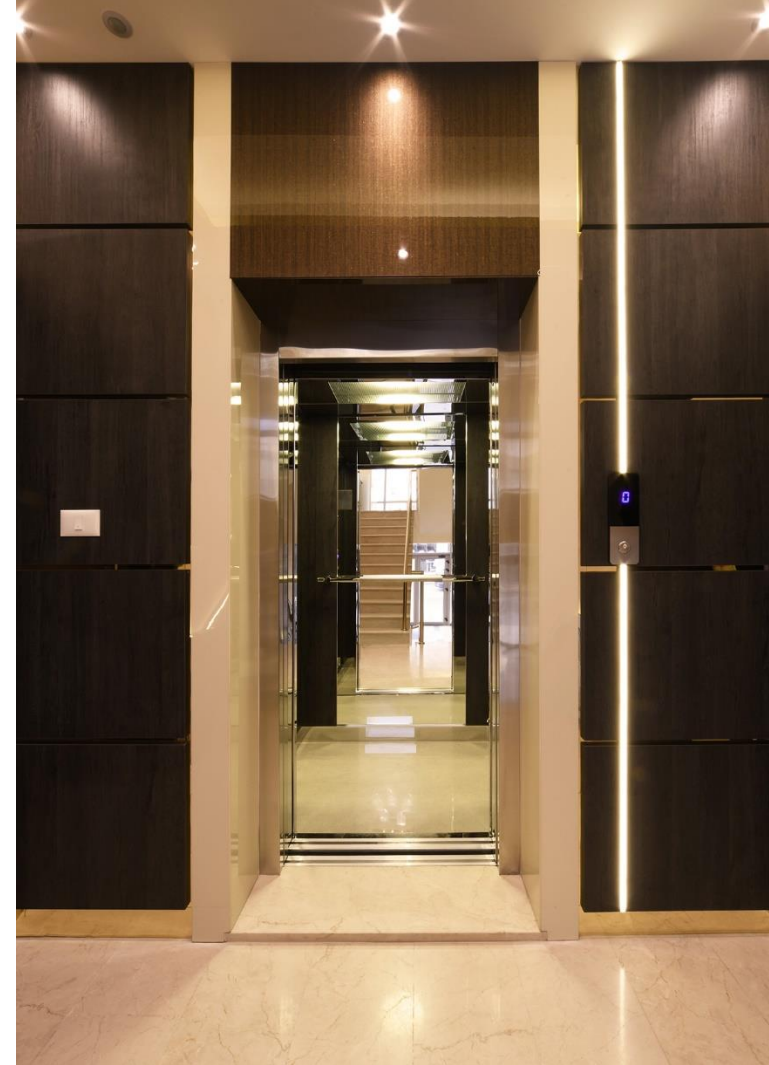

ENTRANCE



FLOOR PLANS

TajAlSafa

TAJ AL SAFA REAL ESTATE DEVELOPMENT

BASEMENT FLOOR

SWEIFYEH APARTMENT 200 SQM

ZONED AREAS

- ▣ 3 BEDROOMS (1 MASTER)

- ▣ GUEST ROOM DINING ZONE

- ▣ LIVING ROOM KITCHEN

- ▣ MAID'S ROOM (WITH BATHROOM)

- ▣ 3 BATHROOMS

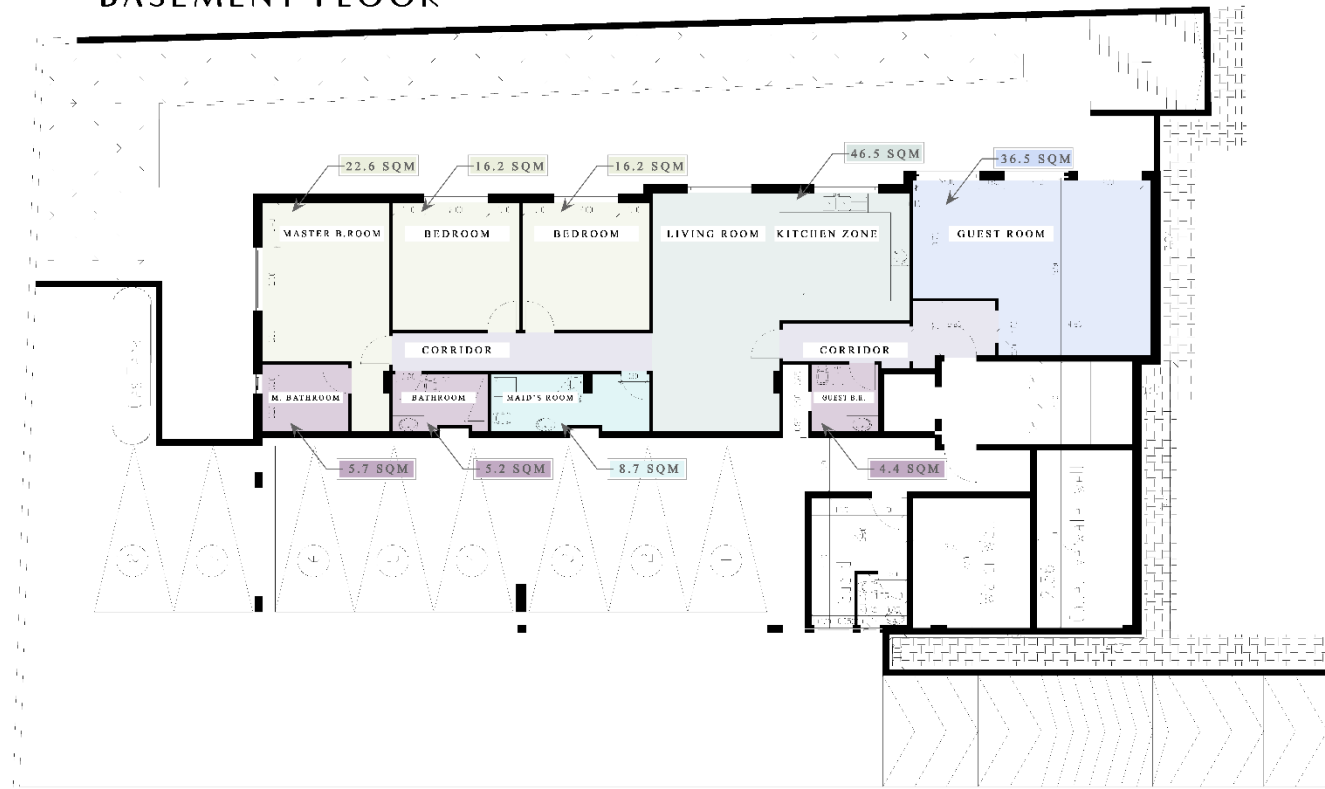

LEGEND

- BEDROOMS
- FAMILY ZONE
- BATHROOM
- CORRIDOR
- GUEST ROOM

FLOOR PLANS

SWEIFYEH APARTMENT 200 SQM

- ZONED AREAS
- ▣ 3 BEDROOMS (1 MASTER)
 - ▣ GUEST ROOM DINING ZONE
 - ▣ LIVING ROOM KITCHEN
 - ▣ MAID'S ROOM (WITH BATHROOM)
 - ▣ 3 BATHROOMS

GROUND FLOOR



LEGEND

- ▣ BEDROOMS
- ▣ FAMILY ZONE
- ▣ BATHROOM
- ▣ CORRIDOR
- ▣ GUEST ROOM

FLOOR PLANS

FIRST FLOOR

SWEIFYEH APARTMENT 200 SQM

- ZONED AREAS
- ▣ 3 BEDROOMS (1 MASTER)
 - ▣ GUEST ROOM DINING ZONE
 - ▣ LIVING ROOM KITCHEN
 - ▣ MAID'S ROOM (WITH BATHROOM)
 - ▣ 3 BATHROOMS

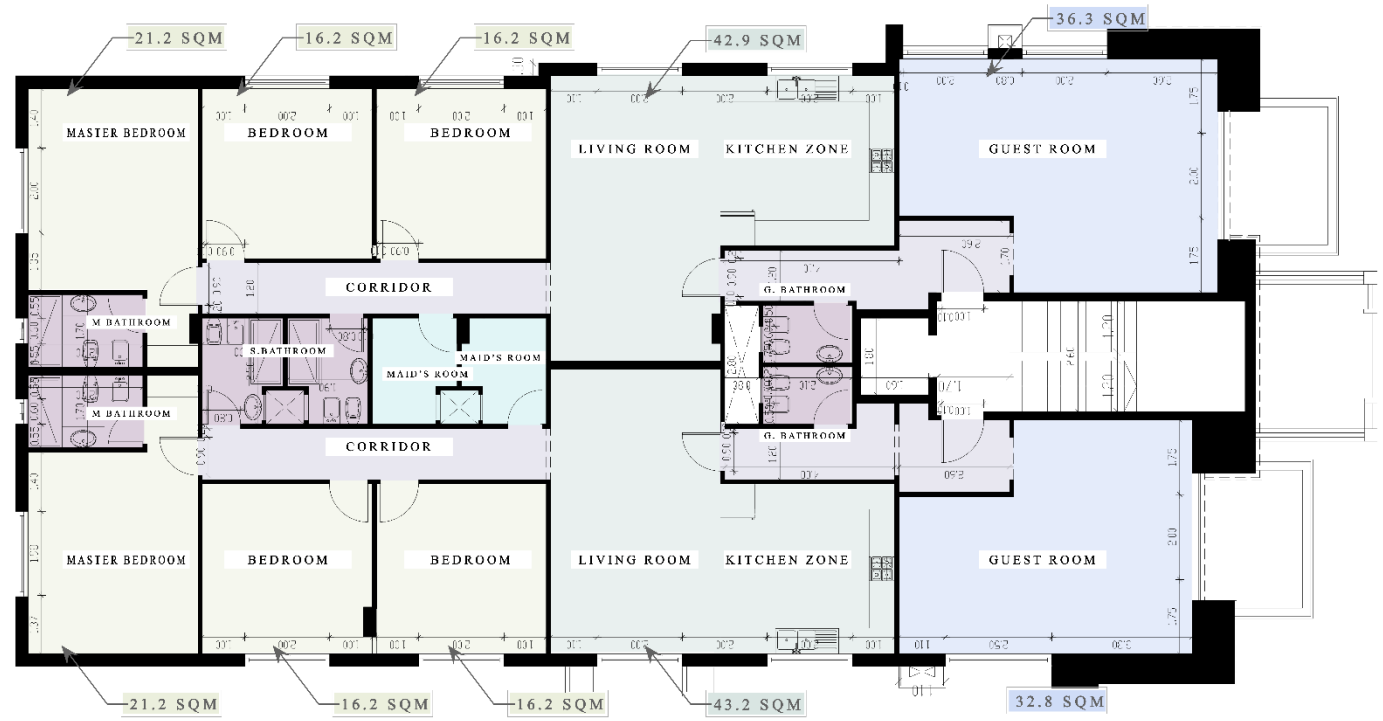

LEGEND

- BEDROOMS
- FAMILY ZONE
- BATHROOM
- CORRIDOR
- GUEST ROOM

FLOOR PLANS

THIRD FLOOR

SWEIFYEH APARTMENT 200 SQM

ZONED AREAS

- ▣ 3 BEDROOMS (1 MASTER)
- ▣ GUEST ROOM DINING ZONE
- ▣ LIVING ROOM KITCHEN
- ▣ MAID'S ROOM (WITH BATHROOM)
- ▣ 3 BATHROOMS

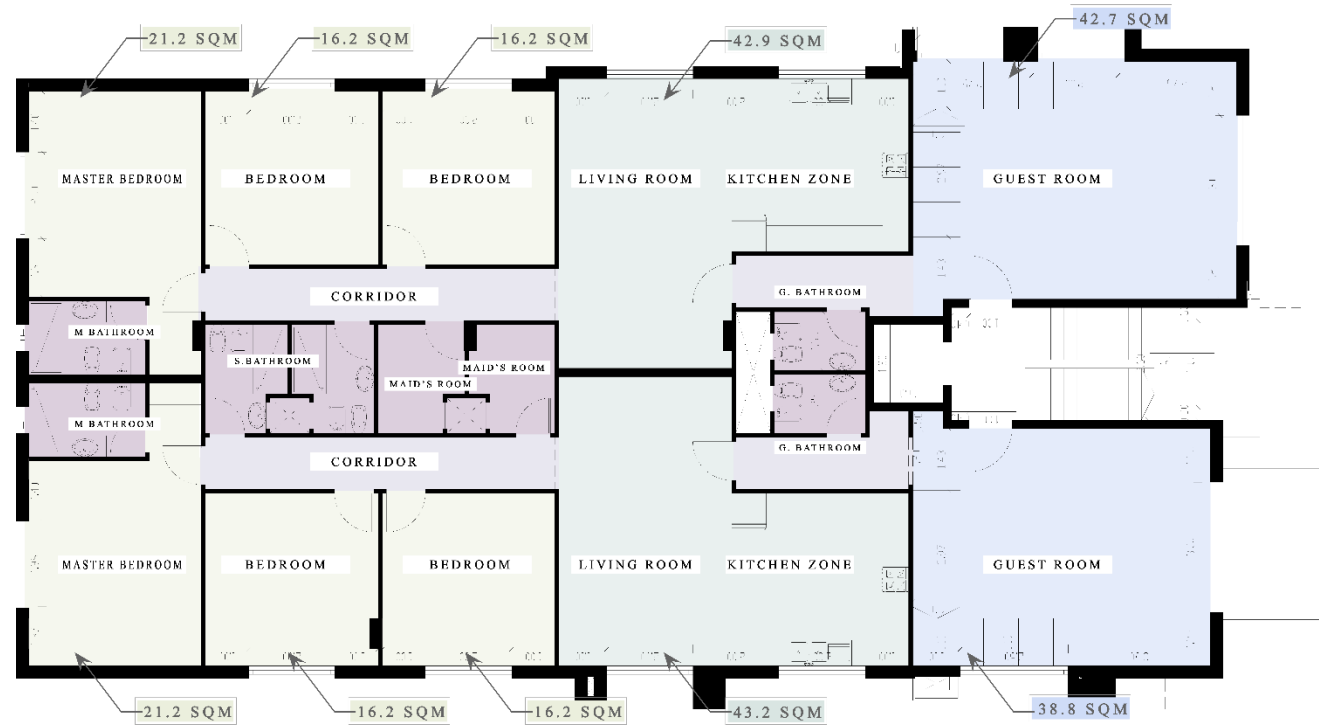

LEGEND

- ▣ BEDROOMS
- ▣ FAMILY ZONE
- ▣ BATHROOM
- ▣ CORRIDOR
- ▣ GUEST ROOM

FLOOR PLANS

ROOF FLOOR

SWEIFYEH HIGH END DUBLEX

230 SQM

ZONED AREAS

- ▣ 3 BEDROOMS
(1 MASTER)

- ▣ GUEST ROOM
DINING ZONE

- ▣ 2 LIVING ROOM
KITCHEN

- ▣ MAID'S ROOM
(WITH BATHROOM)

- ▣ 3 BATHROOMS

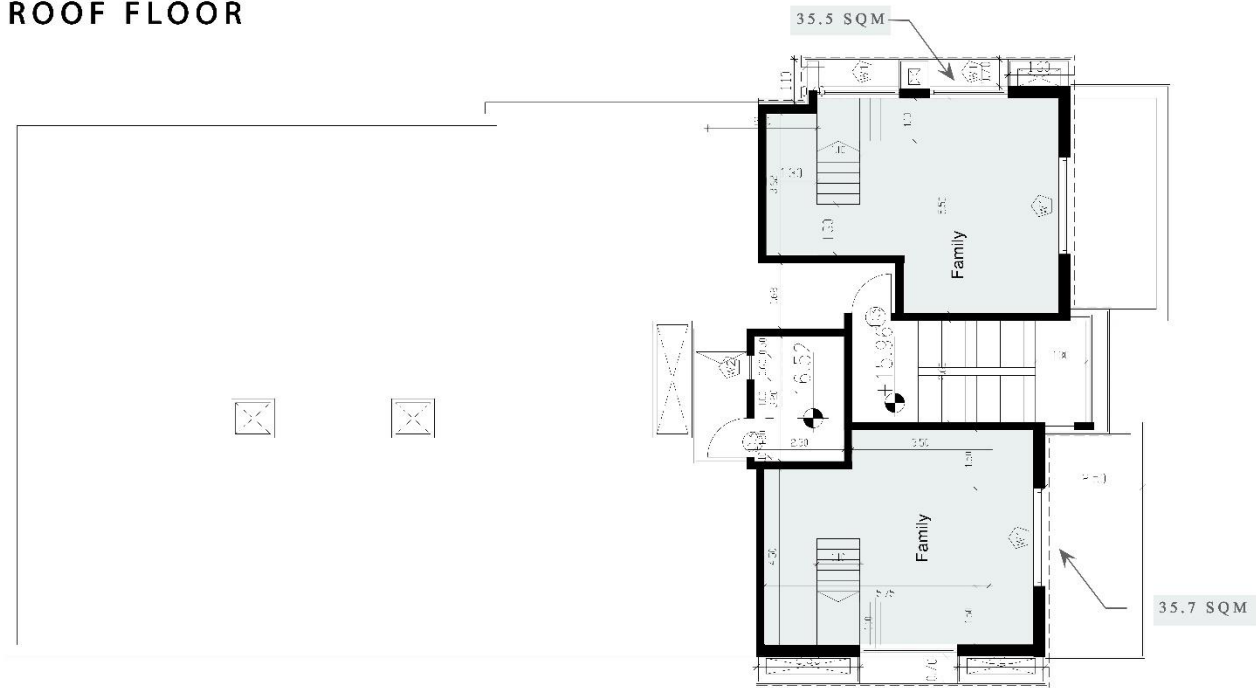

LEGEND

- BEDROOMS
- FAMILY ZONE
- BATHROOM
- CORRIDOR
- GUEST ROOM

PROJECT SPECIFICATIONS

In this project, external wall insulation is used; it is a composite cladding system of appropriate insulation and waterproof coating; it is an essential building energy-saving technology that prevents heat gain/loss through the building envelope.



DOUBLE GLAZED WINDOWS

The energy efficiency of double-glazed windows is excellent, and they also have the added advantage of reducing noise. As an additional layer of insulation, the air gap is tightly sealed between the two panes. Because of the increased thermal resistance, less heat escapes throughout the winter, keeping your house warmer.



ALUMINUM WINDOW FRAME

The project included the installation of specially designed aluminum frames that differed from the rest of the aluminum sections by having the following characteristic features:

- The thickness of the floor is 0.7 mm.
- Italian LAVAL Window lock
- Double Zipper Stainless Wheel Fiber glass window screen.
- 6 mm clear glass+ void 14 mm +5.5 mm clear double silicone.
- AGC- Obeikan glass.



WINDOW SHUTTERS

- Calm motor, 30 and 40 Newton, with a warranty of 15 years, replacement.
- Use of acid-free silicone.
- All silicone works are to the highest specifications in the application (waterproofing + special silicone blade).
- Higher density sedra foam which gives it a higher insulation value and more durability
- The glass is perforated and contains silica gel granules to absorb moisture.
- The column of the shutter is iron, about 6 cm thick, with a thickness of 0.5 mm.



02 INTERIOR

SWIEFIEH PROJECT



CONTENTS



F L O O R P L A N S



C E I L I N G P L A N S



I N T E R I O R 3 D

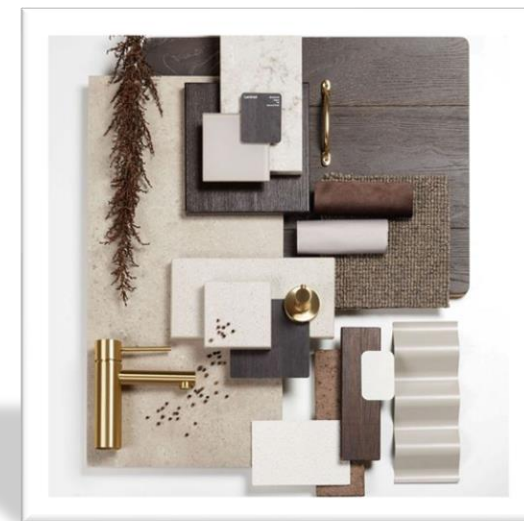

M A T E R I A L

SWEIFIEH PROJECT

TAJ AL SAFA APARTMENT 3 BEDROOMS

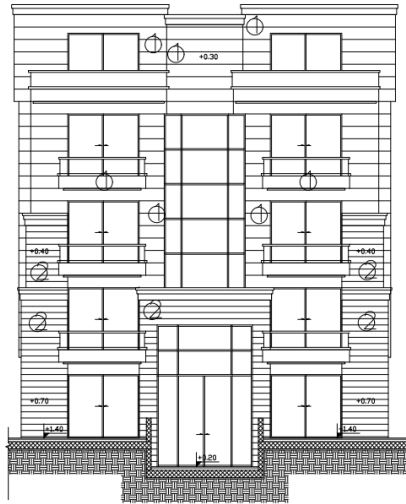

19.08	84
18.98	83
18.88	82
18.78	81
18.68	80
18.58	79
18.48	78
18.38	77
18.28	76
18.18	75
18.08	74
17.98	73
17.88	72
17.78	71
17.68	70
17.58	69
17.48	68
17.38	67
17.28	66
17.18	65
17.08	64
16.98	63
16.88	62
16.78	61
16.68	60
16.58	59
16.48	58
16.38	57
16.28	56
16.18	55
16.08	54
15.98	53
15.88	52
15.78	51
15.68	50
15.58	49
15.48	48
15.38	47
15.28	46
15.18	45
15.08	44
14.98	43
14.88	42
14.78	41
14.68	40
14.58	39
14.48	38
14.38	37
14.28	36
14.18	35
14.08	34
13.98	33
13.88	32
13.78	31
13.68	30
13.58	29
13.48	28
13.38	27
13.28	26
13.18	25
13.08	24
12.98	23
12.88	22
12.78	21
12.68	20
12.58	19
12.48	18
12.38	17
12.28	16
12.18	15
12.08	14
11.98	13
11.88	12
11.78	11
11.68	10
11.58	9
11.48	8
11.38	7
11.28	6
11.18	5
11.08	4
10.98	3
10.88	2
10.78	1
10.68	0

SWEIFYEH APARTMENT 200 SQM

- ZONED AREAS
- ▣ 3 BEDROOMS (1 MASTER)
 - ▣ GUEST ROOM DINING ZONE
 - ▣ LIVING ROOM KITCHEN
 - ▣ MAID'S ROOM (WITH BATHROOM)
 - ▣ 3 BATHROOMS

GROUND FLOOR

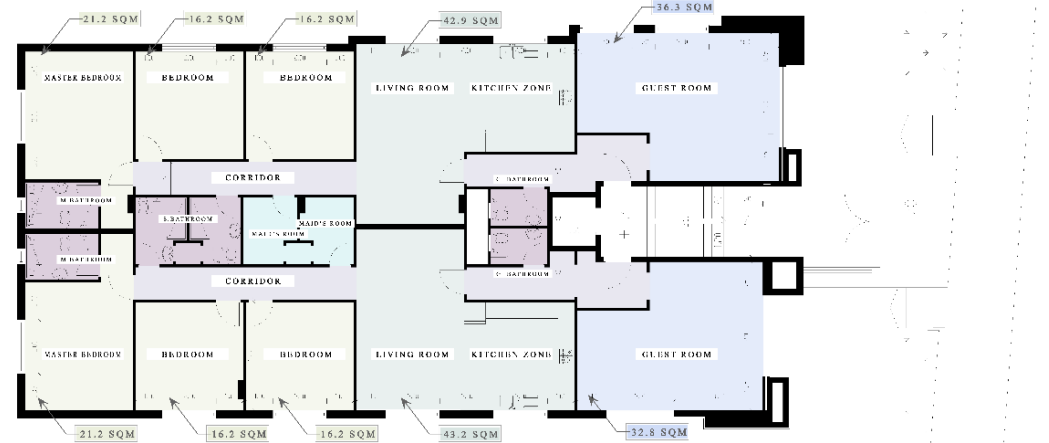

LEGEND

- BEDROOMS
- FAMILY ZONE
- BATHROOM
- CORRIDOR
- GUEST ROOM

TOTAL AREA 200 SQ.M.

SWEIFIEH PROJECT

TAJ AL SAFA

High-End Duplex

3 BEDROOMS

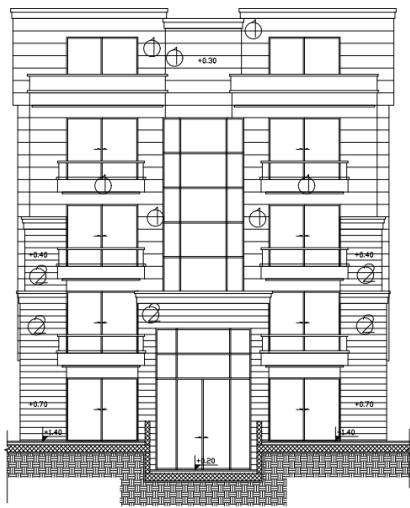

THIRD FLOOR

SWEIFYEH APARTMENT
200 SQM

- ZONED AREAS
- ▣ 3 BEDROOMS (1 MASTER)
 - ▣ GUEST ROOM DINING ZONE
 - ▣ LIVING ROOM KITCHEN
 - ▣ MAID'S ROOM (WITH BATHROOM)
 - ▣ 3 BATHROOMS

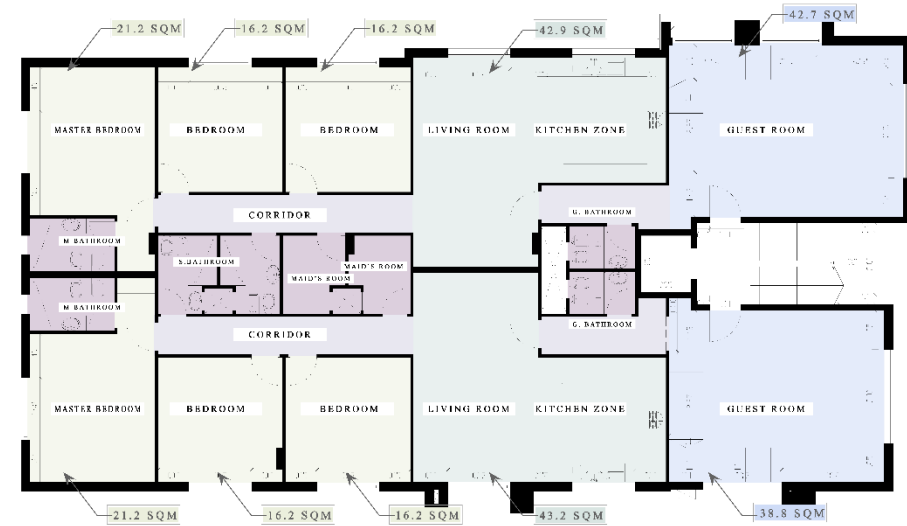

LEGEND

- BEDROOMS
- FAMILY ZONE
- BATHROOM
- CORRIDOR
- GUEST ROOM

TOTAL AREA 240 SQ.M.

INTERNAL SPACES

Taj Safa



01

Guest Room

COLORS:



02

Dining Area

COLORS:



03

Living Room

COLORS:



INTERNAL SPACES

Taj Safa



04

KITCHEN

COLORS: ● ● ● ●



05

MASTER
BEDROOM

COLORS: ● ● ● ●



06

KIDS BEDROOM

COLORS: ● ● ● ●

INTERNAL SPACES

Taj Safa



07

KIDS
BEDROOM

COLORS: ● ● ● ●



08

GUEST
BATHROOM

COLORS: ● ● ● ●



09

MASTER
BATHROOM

COLORS: ● ● ● ●

INTERNAL SPACES

Taj Safa



10

SHARED
BATHROOM

COLORS: ● ● ● ●



11

CORRIDOR

COLORS: ● ● ● ●

GUEST ROOM

TajAlSafa

TAJ AL SAFA REAL ESTATE DEVELOPMENT



GUEST ROOM



DINING ROOM

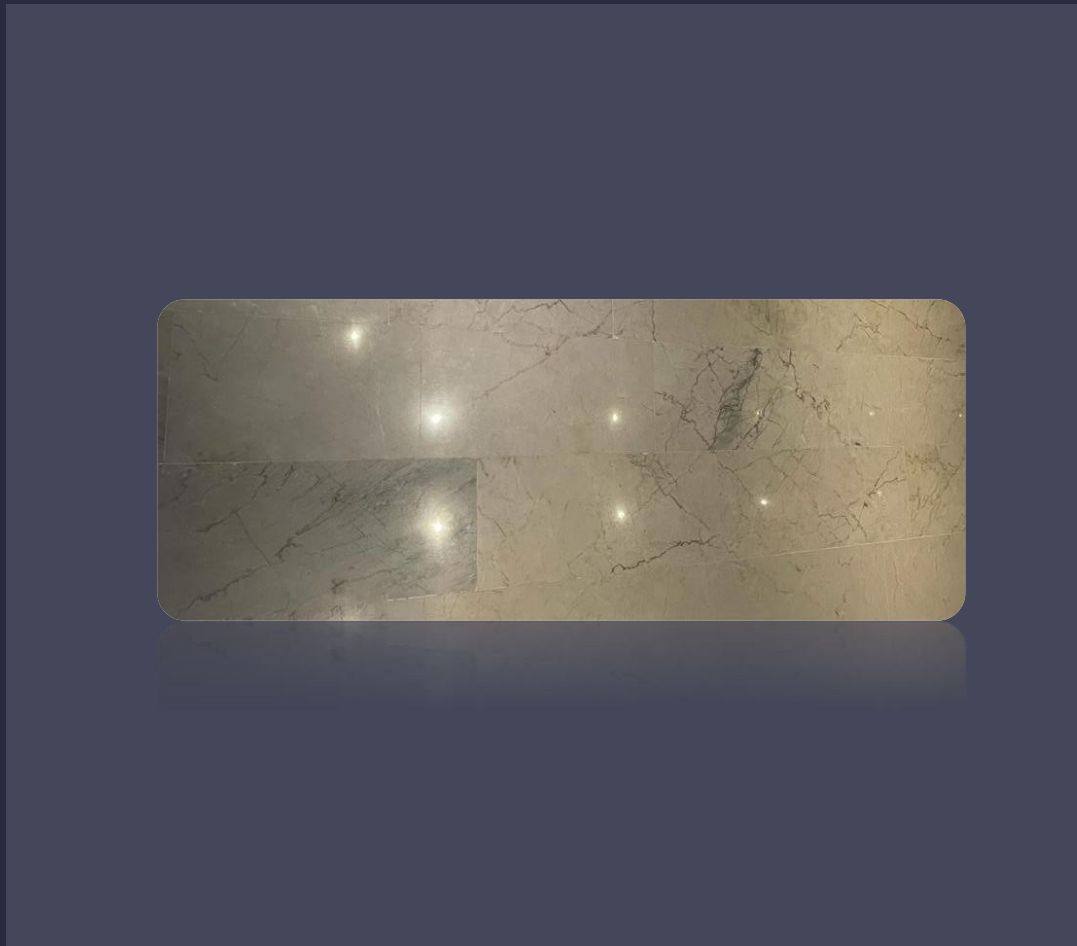

FRAPACINO MARBLE



LOCATION: GUEST ROOM

FINISH: MARBLE

SURFACE: GLOSSY

Origin: ITALY

SIZE: 120 X 60 CM

LIVING ROOM

Taj Al Safa

TAJ AL SAFA REAL ESTATE DEVELOPMENT





External Door



Description: A high-quality door with a wood veneer design. It provides thermal and sound insulation

Security system: HOK door lock (Seven security locks).

High-quality magic eye.





Top-rated Turkish Aluminum Door Handle

Internal Door



Description: The internal doors used in the project are soundproof and resistant to heat, humidity, and we tness. They are full HDF coated with a layer of Germa n PVC, which protects the door and gives it a beautiful color and shape.

KITCHEN







PERONDAGROUP



SENSE G/R



LOCATION: KITCHEN

Origin: Spain

COLOR: GREY

CODE:113965

SIZE: 33.3 X 100 CM



PERONDAGROUP

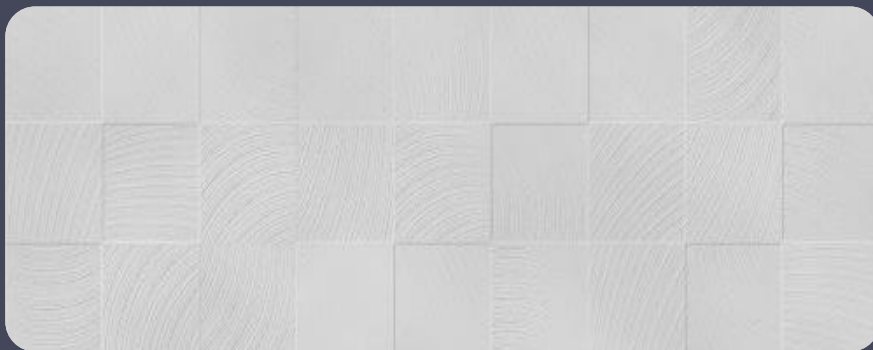

FEELING G/R



LOCATION: KITCHEN

SURFACE: 3D

Origin: Spain

CODE: 113961

COLOR : GREY

SIZE: 33.3 X 100 CM

ARGENTA



PALCO DARK



LOCATION: KITCHEN

SURFACE: GLAZED PORCELAIN

Origin: Spain

SERIES: PALCO

SIZE: 60 X 60 CM

SURFACE: FLOOR TILES



MASTER BEDROOM



A Tempered Glass door was installed in the bathroom to create a modern interior design style.



MASTER BEDROOM DESIGN



MASTER BEDROOM DESIGN

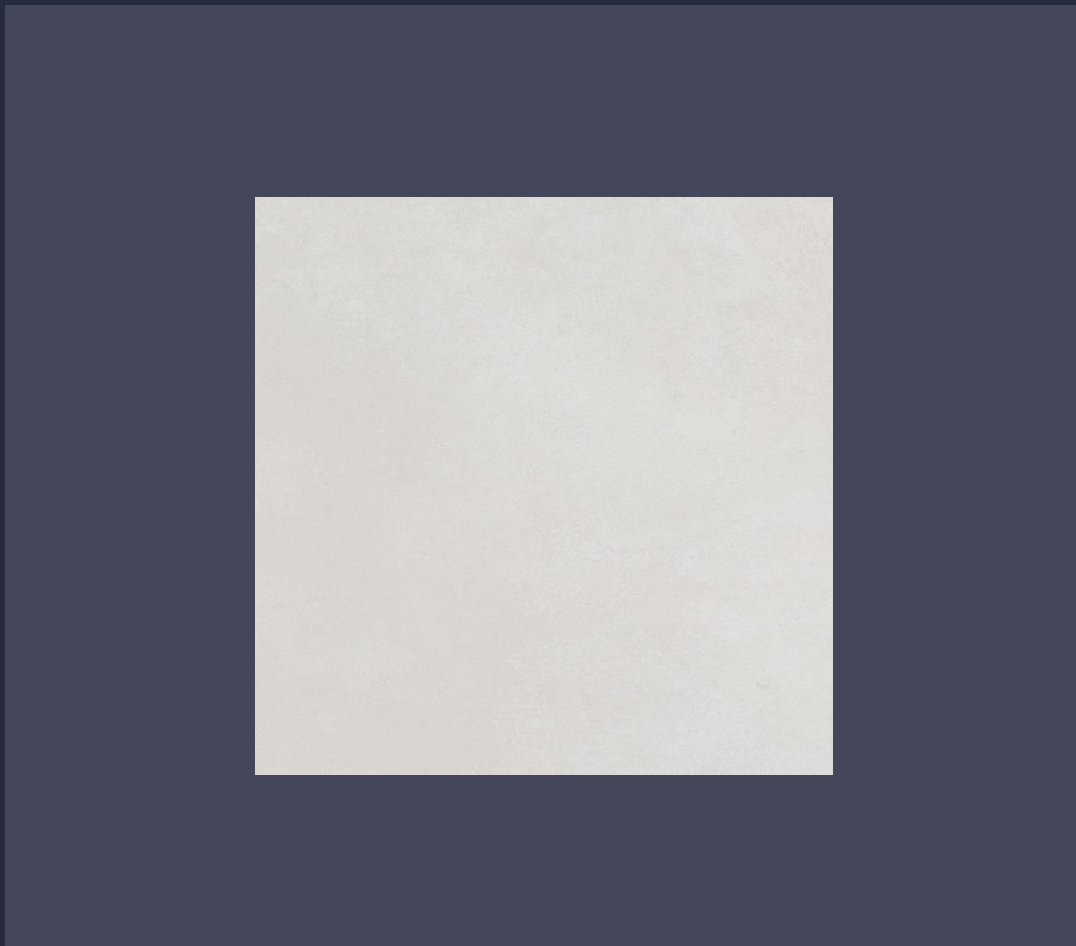

SL RANDOM BLANC



LOCATION: MASTER BEDROOM

SURFACE: PARQUET

Origin: Spain

SIZE: 60 X 60 CM

SURFACE: FLOOR TILES

BEDROOMS

TajAlSafa





SL RANDOM BLANC



LOCATION: BEDROOMS

SURFACE: PARQUET

Origin: Spain

SIZE: 60 X 60 CM

SURFACE: FLOOR TILES

MASTER BATHROOM

TajAlSafa

TAJ AL SAFA REAL ESTATE DEVELOPMENT



GRES PANIA



NARBONNE MARF



LOCATION: MASTER BATHROOM

SURFACE: PORCELAIN

FINISH: MATT

Origin: Spain

SIZE: 31.5 X 100 CM

SURFACE: FLOOR TILES

GRESPANIA

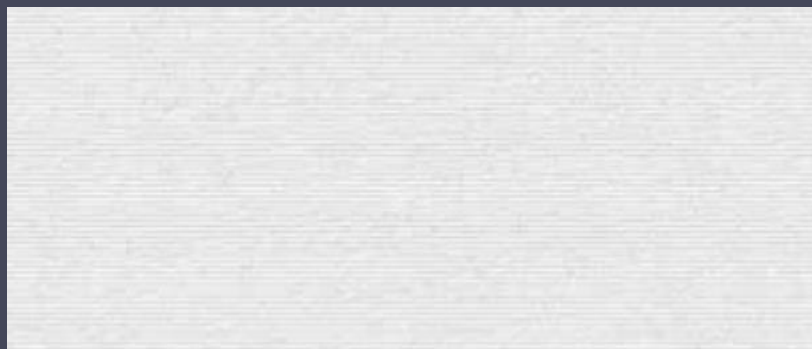

BEZIERS MARF



LOCATION: MASTER BATHROOM

SURFACE: PORCELAIN

FINISH: MATT

Origin: Spain

SIZE: 31.5 X 100 CM

SURFACE: FLOOR TILES

GRES PANIA

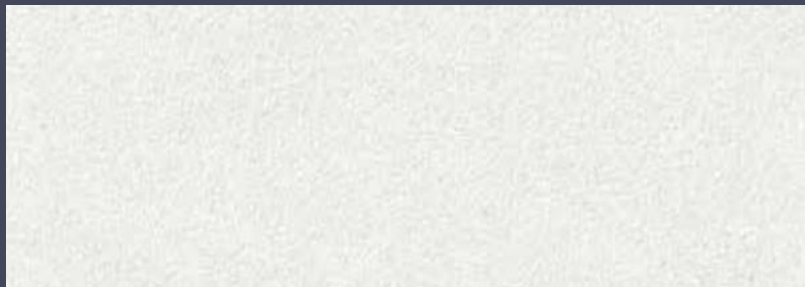

REIMS MARF



LOCATION: MASTER BATHROOM

SURFACE: PORCELAIN

FINISH: MATT

Origin: Spain

SIZE: 31.5 X 100 CM

SURFACE: FLOOR TILES



MUMBLE



LOCATION: MASTER BATHROOM

SURFACE: PORCELAIN

Origin: Spain

SIZE: 90 X 15 CM

SURFACE: FLOOR TILES



UNDER COUNTER BASIN



LOCATION: MASTER BATHROOM

CODE: CNS-WHT-701

RANGE: CONTEINENTAL SERIES

BRAND: JAQUAR

SIZE: 485x370x205 mm



SINGLE LEVER EXTENDED BASIN MIXER



LOCATION: MASTER BATHROOM

CODE: ARI-CHR-39023B

RANGE: ARIA

BRAND: JAQUAR

FINISH: CHROME

GROHE

UNISSET 2-in-1 Set for WC (Grohe)



LOCATION: MASTER BATHROOM
CODE: 38 825 00D
COLOR: CHROME
SKATE COSMOPOLITAN FLUSH PLATE, CHROME.

Description: Electric WC flushing system that is ideal for use in bathroom furniture. It saves water and allows the user to select the amount of water used, either 6 L or 9 L. It is leak-tested, sound-insulating, simple to install, and concealed within the bathroom wall.



ROCA NEXO WALL HUNG RIMLESS



LOCATION: MASTER BATHROOM

CODE: A34664L00M

COLOR: WHITE

MOUNTING TYPE: WALL-HUNG TOILETS

DIMENSIONS: 360x535x405 [mm]



SHOWER PANEL



LOCATION: MASTER BATHROOM

FINISH: CHROME

SHAPE: RECTANGULAR

SHARED BATHROOM

TajAlSafa

TAJ AL SAFA REAL ESTATE DEVELOPMENT





RIVER GRIS



LOCATION: SHARED BATHROOM

SURFACE: PORCELAIN

Origin: Spain

SIZE: 30 X 90 CM

SURFACE: FLOOR TILES



RIVER ROMBOS



LOCATION: SHARED BATHROOM

SURFACE: PORCELAIN

Origin: Spain

SIZE: 30 X 90 CM

SURFACE: FLOOR TILES



RIVER SPIRIT GRIS



LOCATION: SHARED BATHROOM

SURFACE: PORCELAIN

Origin: Spain

SIZE: 30 X 90 CM

SURFACE: FLOOR TILES



MUMBLE G/R



LOCATION: SHARED BATHROOM

SURFACE: PORCELAIN

Origin: Spain

SIZE: 15 X 90 CM

SURFACE: FLOOR TILES



ROCA DEBBA ROUND RIMLESS WALL-HUNG TOILET



LOCATION: SHARED BATHROOM

CODE: A34664L00M

COLOR: WHITE

MOUNTING TYPE: WALL-HUNG TOILETS

DIMENSIONS: 355x540 [mm]

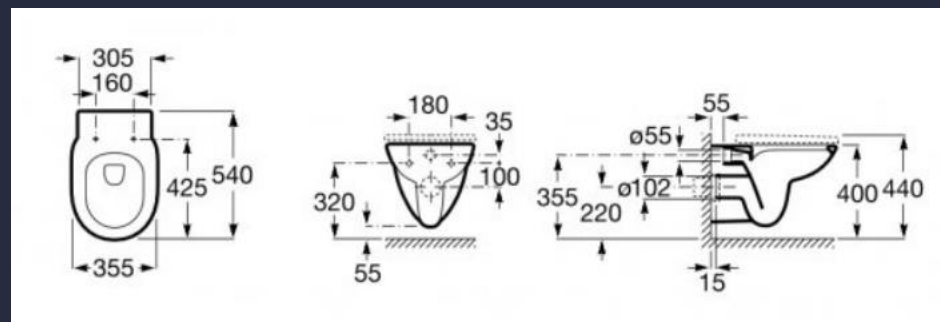

GROHE

UNISSET 2-in-1 Set for WC (Grohe)



LOCATION: SHARED BATHROOM
CODE: 38 825 00D
COLOR: CHROME
SKATE COSMOPOLITAN FLUSH
PLATE

Description: Electric WC flushing system that is ideal for use in bathroom furniture. It saves water and allows the user to select the amount of water used, either 6 L or 9 L. It is leak-tested, sound-insulating, simple to install, and concealed within the bathroom wall.

Roca



ROCA THE GAP BASIN AND SEMI PEDESTAL



LOCATION: SHARED BATHROOM

CODE: 2784753

COLOR: WHITE

DIMENSIONS:

SHAPE: RECTANGULAR

STYLE: MODERN



VITRA BASIN MIXER



LOCATION: SHARED BATHROOM
COLOR: CHROME

GUEST BATHROOM





ONIX PEARL



LOCATION: GUEST BATHROOM

SURFACE: PORCELAIN

Origin: SPAIN

FINISH: POLISHED

SIZE: 75.5 X 151 CM

SURFACE: FLOOR TILES



LAURENT BLACK



LOCATION: GUEST BATHROOM

SURFACE: PORCELAIN

Origin: Spain

FINISH: POLISHED

SIZE: 75.5 X 151 CM

COLOUR: ST LAURENT BLACK

SURFACE: FLOOR TILES



ROCA DEBBA ROUND RIMLESS WALL-HUNG TOILET



LOCATION: GUEST BATHROOM

CODE: A34664L00M

COLOR: WHITE

MOUNTING TYPE: WALL-HUNG TOILETS

DIMENSIONS: 355x540 [mm]

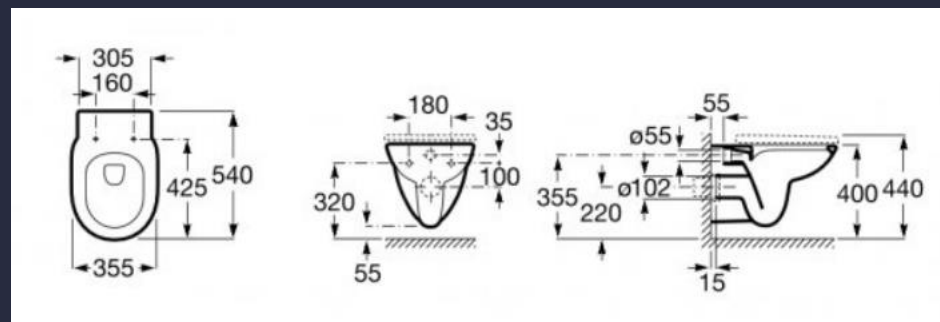

GROHE

UNISSET 2-in-1 Set for WC (Grohe)



LOCATION: GUEST BATHROOM
CODE: 38 825 00D
COLOR: CHROME
SKATE COSMOPOLITAN FLUSH PLATE, CHROME.

Description: Electric WC flushing system that is ideal for use in bathroom furniture.

It saves water and allows the user to select the amount of water used, either 6 L or 9 L. It is leak-tested, sound-insulating, simple to install, and concealed within the bathroom wall.



OVER COUNTER BASIN



LOCATION: GUEST BATHROOM
CODE: 076400-u
COLOR: WHITE



GROHE FAUCETS



LOCATION: GUEST BATHROOM
CODE: 076400-u
FINISH: CHROME

MAIDS BATHROOM



JERTE WHITE



LOCATION: MAIDS BATHROOM

Origin: SPAIN

SIZE: 30 X 60 CM

SURFACE: FLOOR TILES



For more information or to book a viewing tour, get in touch with our marketing team.

00962795520443

00962799263003

<http://www.taj-alsafa.com/>

Taj_alsafa@yahoo.com

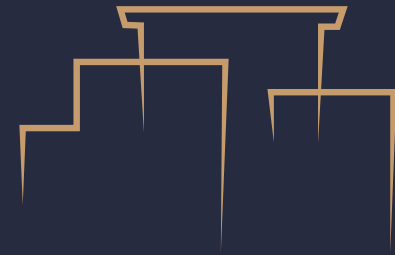

TAJ ALSAFA

REAL ESTATE DEVELOPMENT
